

Modern Door Seal Replacement Reference

20 (Taylor Panel)

Weather Seal #	SBT Part Number	Description	Where Used
OBS	WS-007-6/8	SEAL-20JB-BRN81	Bronze 6-8 jamb seal 81" (6/8)
OBS	WS-007-7/0	SEAL-20JB-BRN86	Bronze 7-0 jamb seal 86" (7/0)
OBS	WS-008		Bronze 3-0 seal [35.8125] - 6 fin - Obsolete 3/2006
OBS	WS-020	SEAL-20TB-BRN30	Bronze 2-6 seal [29.8125] - 1 bulb / 3 fin alcryn 7083
OBS	WS-020	SEAL-20TB-BRN32	Bronze 2-8 seal [31.8125] - 1 bulb / 3 fin alcryn 7083
OBS	WS-020	SEAL-20TB-BRN36	Bronze 3-0 seal [35.8125] - 1 bulb / 3 fin alcryn 7083
OBS	WS-020	SEAL-20TB-BRN37	Bronze 3-1 seal [37.0000] - 1 bulb / 3 fin alcryn 7083
OBS	WS-020		Bronze 3-6 seal [41.8125] - 1 bulb / 3 fin alcryn 7083
OBS	WS-020	SEAL-20TB-BRN48	Bronze 4-0 seal [47.7500] - 1 bulb / 3 fin alcryn 7083
OBS	WS-020	SEAL-20TB-BRN49	Bronze 4-1 seal [48.9375] - 1 bulb / 3 fin alcryn 7083

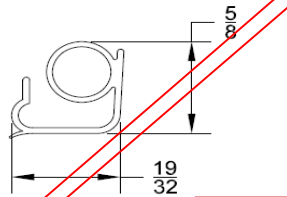

Obsolete
WS-007

No Longer Available

(Used from 2000 - August 2015)
All jamb seals 6/8 & 7/0

No longer available -replace with WS-016

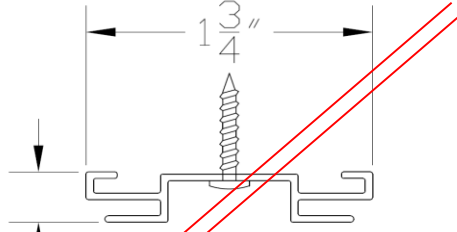

ADA Seal Extension # 1572

Used with WS-020 on the bottom of panel for Handicap-accepted threshold and the outswing threshold. Adds 1/4" length to door panel. (2001 - April 2013)

No longer available

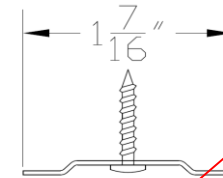

Obsolete

Series 20 "Taylor" Seal-holder
Most recent (2012) - needed for all WS-020 applications.

Top and bottom of "old" Series 20 universal swing doors. (2000 - 2013)

Some available for repair

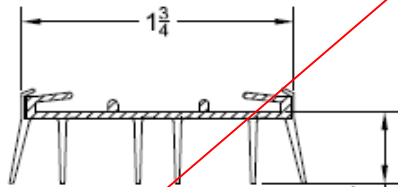

Obsolete
WS-008

Available for replacement

Used 2000 - 2006, 2018 - current for replacement.

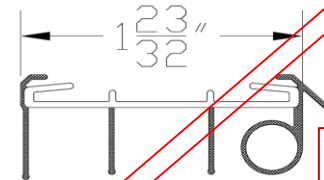

Obsolete
WS-020

No Longer Available -
For replacement orders, use WS-008

Most recent (2012) - works for all "old" Series 20 doors, top and bottom of door. (2006 - April 2013)

Modern Door Seal Replacement Reference

20EL

Weather Seal #	SBT Part Number	Description	Where Used	
WS-006E-3/0	SEAL-99EBR36	Bronze T&B seal [35.750] Everlast alcryn 4670	24E, 99E, 95E, 20E, 32E, 92E	
WS-006E	SEAL-99EBR37	Bronze T&B seal [37.000] Everlast alcryn 4670	Double Door - 99E, 95E, 20E, 32E, 92E	
WS-006E-4/0	SEAL-99EBR48	Bronze T&B seal [47.750] Everlast alcryn 4670	24E, 99E, 95E, 20E, 32E, 92E	
WS-006E	SEAL-99EBR49	Bronze T&B seal [49.000] Everlast alcryn 4670	Double Door - 99E, 95E, 20E, 32E, 92E	
OBS	WS-007-6/8	SEAL-20JB-BRN81	Bronze 6-8 jamb seal 81"	20, 20E, 32D, 25
OBS	WS-007-7/0	SEAL-20JB-BRN86	Bronze 7-0 jamb seal 86"	20, 20E, 32D
	DUSTPLUG-1.25	1 1/4" Wide Dust Plug, Gray	20 ins., 31, 35, 88, 94, 96, 99, 99 double door, 99E	
WS-011-6/8	SEAL-92S-BRN81	Bronze Q-lon seal 81"	32, 55, 92E, 27, 95E, 98, (20E Full Header only)	
WS-011-7/0	SEAL-92S-BRN86	Bronze Q-lon seal 86"		
WS-016-6/8	SEAL-20JBQ-BN81	Bronze 6-8 jamb seal 81"	20, 20E, 20E Header Stop, 20E Atr., 25, 32D Ast., 88, 92E Ast., 95 (picture frame), 95E Ast., 99E Ast.,	
WS-016-7/0	SEAL-20JBQ-BN86	Bronze 7-0 jamb seal 86"		

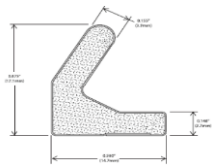

WS-016

Current
(August 2015 - current)

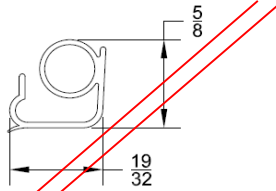

Obsolete

WS-007

(2000 - August 2015)

All 20 series jambs 6/8 and 7/0

No Longer Available - replace with WS-016

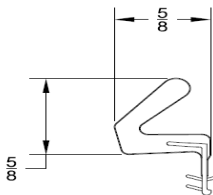

WS-011

Compression Jamb Seal

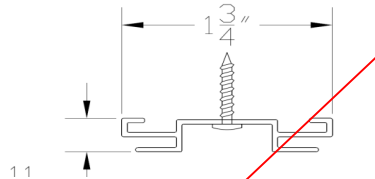

ADA Seal Extension # 1572

Used on the bottom of panel for Handicap-accepted threshold and the outswing threshold. Changed to Extension #1929 about 11-1-2013

No longer available

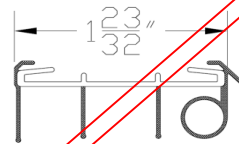

Obsolete

WS-020

Recent (2012) - Used with above ADA Seal Extension until about 11-1-2013

No Longer Available Use WS-008 for replacement

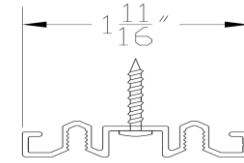

ADA and outswing Extension #1929 for WS-006E Bottom Seal - ADA thresholds and outswing doors. (Sept 2013 - current)

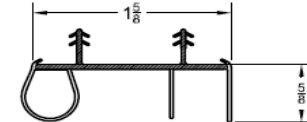

EVERLAST SWEEP

WS-006E

(2013 - Current)

Top of all Series 20 Everlast Doors and bottom of universal and in-swing doors until approx. 11-1-2013. After that, this became the one seal for all Series 20 Everlast doors.

Modern Door Seal Replacement Reference

22 / 23 Amweld, OSG or Mesker

Weather Seal #	SBT Part Number	Description	Where Used	
WS-019	23SEALBK17	Black bulb adh. Weatherseal - fire rated	22	
WS-022	SEAL-23BTLP-36	36" vinyl bottom seal w/ alum. Low profile U-channel	22, 23	
WS-022	SEAL-23BTLP-48	48" vinyl bottom seal w/ alum. Low profile U-channel	22, 23	
WS-023	SEAL-23USWEEP36	36" vinyl bottom seal w/ alum. U-channel	22, 23	
WS-023	SEAL-23USWEEP48	48" vinyl bottom seal w/ alum. U-channel	22, 23	
WS-024	SEAL-23JB-3684	36 x 84 aluminum mf / Foam Tite weather strip kit	23, 24	
WS-024W	SEAL-23JB-3684W	36 x 84 aluminum mf / Foam Tite weather strip kit	23, 24	
OBS	WS-892	SEAL-ALUM3684	36 x 84 aluminum / vinyl weather strip kit	23, 24 - Obsolete 7/2006 - replace with WS-024
OBS	WS-892	SEAL-ALUM4884	48 x 84 aluminum / vinyl weather strip kit	23, 24 - Obsolete 7/2006 - replace with WS-024
WS-770	SWEEP-3/0	36" VINYL BOTTOM SWEEP W/ ALUM DRIP	22,23	
WS-770	SWEEP-4/0	48" VINYL BOTTOM SWEEP W/ ALUM DRIP	22,23	

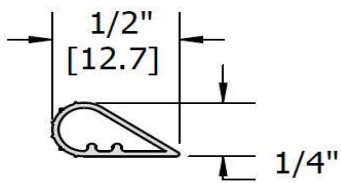

WS-019 Smoke Seal
Series 22

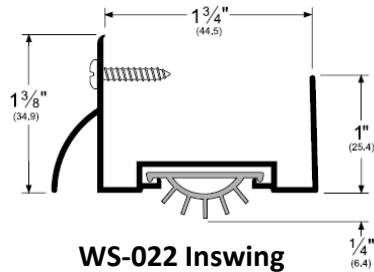

WS-022 Inswing
Replacement for all
doors manufactured
after Feb. 2021

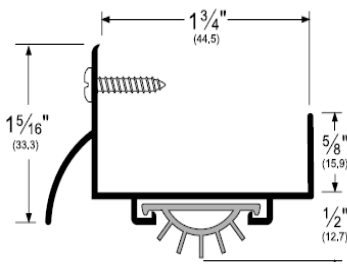

WS-023 Outswing
Replacement for outswing doors
manufactured before Feb. 2021

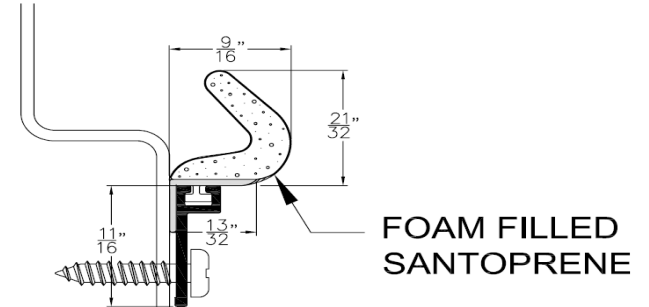

WS-024 Jamb and Header Seal
Standard Jamb Seal for Series 23 & 24 & 24T

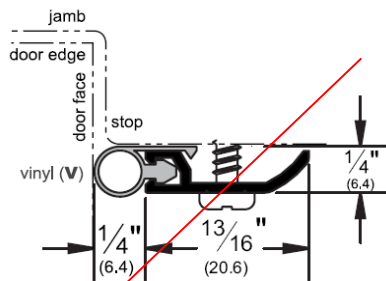

WS-892
Obsolete
(7/31/2006)

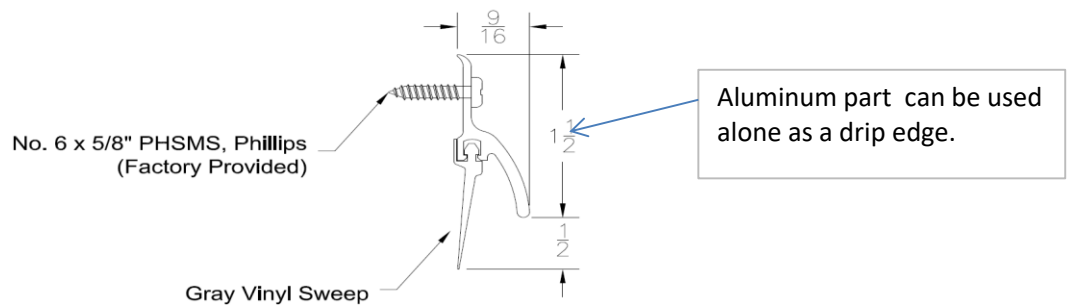

WS-770 SWEEP
Standard Sweep - Series 22 & 23

Modern Door Seal Replacement Reference

24

Weather Seal #	SBT Part Number	Description	Where Used
WS-024	SEAL-23JB-3684	36 x 84 aluminum mf / Foam Tite weather strip kit	23, 24
WS-024W	SEAL-23JB-3684W	36 x 84 aluminum mf / Foam Tite weather strip kit	23, 24
WS-006E-3/0	SEAL-99EBR36	Bronze T&B seal [35.750] Everlast alcryn 4670	24E, 99E, 95E, 20E, 32E, 92E
OBS WS-008		Bronze 3-0 seal [35.8125] - 6 fin - Obsolete 3/2006	20, 24, 27, 28
OBS WS-020	SEAL-20TB-BRN30	Bronze 2-6 seal [29.8125] - 1 bulb / 3 fin alcryn 7083	20, 98, 32out
OBS WS-020	SEAL-20TB-BRN32	Bronze 2-8 seal [31.8125] - 1 bulb / 3 fin alcryn 7083	20, 98, 32out
OBS WS-020	SEAL-20TB-BRN36	Bronze 3-0 seal [35.8125] - 1 bulb / 3 fin alcryn 7083	20, 98, 32out, 24, 25
OBS WS-020	SEAL-20TB-BRN37	Bronze 3-1 seal [37.0000] - 1 bulb / 3 fin alcryn 7083	Double Door 20, 32out
OBS WS-020		Bronze 3-6 seal [41.8125] - 1 bulb / 3 fin alcryn 7083	20, 98, 32out
OBS WS-020	SEAL-20TB-BRN48	Bronze 4-0 seal [47.7500] - 1 bulb / 3 fin alcryn 7083	20, 32out
OBS WS-020	SEAL-20TB-BRN49	Bronze 4-1 seal [48.9375] - 1 bulb / 3 fin alcryn 7083	Double Door 20, 32out

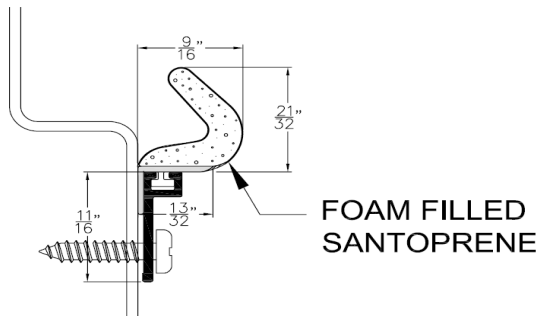

WS-024 Jamb and Header Seal
Standard Jamb Seal for Series 23 & 24 & 24T

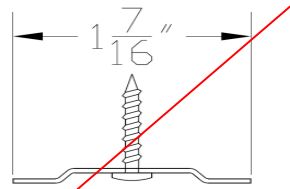

Obsolete
Series 20 "Taylor" Seal-holder
Most recent (2012) - needed for all WS-020 applications.
Bottom of "old" Series 24 doors.
(- 2013)

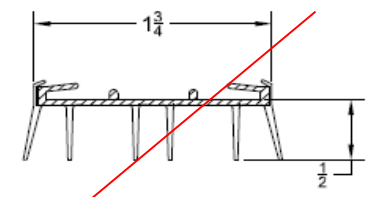

WS-008
Obsolete
(3/2006)

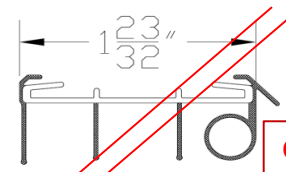

Obsolete
WS-020
Most recent (2012) - works for all "old" Series 24 doors, bottom of door only.
(End 2013)

Out of material - For replacement orders use WS-008

ADA and outswing Extension #1929 for WS-006E Bottom Seal - ADA thresholds and outswing doors.
(Sept 2013 - current)

EVERLAST SWEEP
WS-006E
(2013 - Current)

Top of all Series 20 Everlast Doors and bottom of universal and in-swing doors until approx. 11-1-2013. After that, this became the one seal for all Series 20 Everlast doors.

Modern Door Seal Replacement Reference

27/28

Weather Seal #	SBT Part Number	Description	Where Used
	SEAL-28JB	Black 3/8" silicon bulb kerf seal	28
	SEAL-28JBTAPE	.0450 x .040 x 18ft graphite tape	28
OBS	WS-008	Bronze 3-0 seal [35.8125] - 6 fin - Obsolete	27, 28
	WS-011-6/8	SEAL-92S-BRN81	Bronze Q-lon seal 81" Bronze
	WS-011-7/0	SEAL-92S-BRN86	Q-lon seal 86" 32, 55, 92E, 27, 95E, 98, 20E Full Header

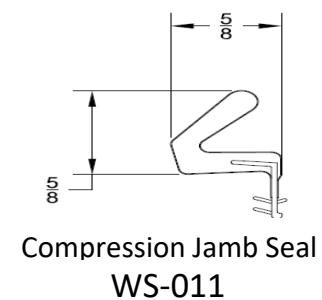
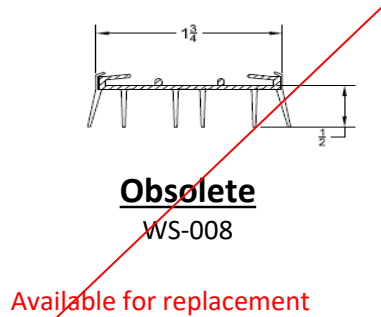
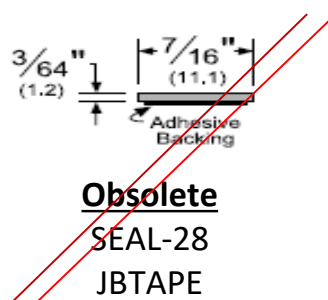

31/35

Weather Seal #	SBT Part Number	Description	Where Used
WS-006-3/0-BRN	SEAL-99TBBERN-35	Bronze T&B seal [35.9375]	99, 94, 95 (Picture Frame), 96, 77
WS-006	SEAL-99TBBERN-37	Bronze T&B seal [37.1875]	double door
WS-006-4/0-BRN	SEAL-99TBBERN-46	Bronze T&B seal [46.4375]	99, 94
WS-006	SEAL-99TBBERN-47	Bronze T&B seal [47.6250]	double door
WS-012	SEAL-99S-WOOLP	(.320-4 High)(.270 wide) gray woolpile weather strip	99, 66, 96, 77, 54, 35, 31, 99E
	DUSTPLUG-1.25	1 1/4" Wide Dust Plug, Gray	20 ins., 31, 35, 88, 94, 96, 99, 99 double door, 99E

****Note: WS-006 panel sweep changed color from white to brown in Oct. 2008**

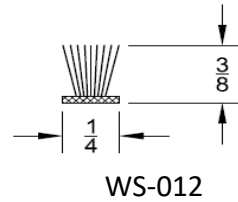
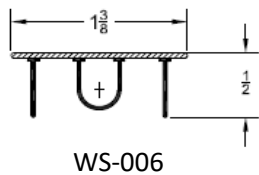

Modern Door Seal Replacement Reference

32E

Weather Seal #	SBT Part Number	Description	Where Used
OBS	WS-005-3/0	SEAL-20TB36-1	Bronze 3-0 seal [35.8125] - screw on 1 bulb / 3 fin
OBS	WS-005-3/8	SEAL-20TB42-1	Bronze 3-6 seal [41.8125] - screw on 1bulb / 3 fin
	WS-011-6/8 WS-011-7/0	SEAL-92S-BRN81 SEAL-92S-BRN86	Bronze Q-Ion seal 81" Q-Ion seal 86"
		Bronze	32, 55, 92E, 27, 95E, 98, 20E Full Header
OBS	WS-020	SEAL-20TB-BRN	Bronze seal - 1 bulb / 3 fin alcryn 7083
		WS-PAD-CORNER	Endura Corner Pad
			32 inswing
	WS-006E-3/0	SEAL-99EBR36	Bronze T&B seal [35.750] Everlast alcryn 4670
			24E, 99E, 95E, 20E, 32E, 92E
	WS-016-6/8 WS-016-7/0	SEAL-20JBQ-BN81 SEAL-20JBQ-BN86	Bronze 6-8 jamb seal 81" Bronze 7-0 jamb seal 86"
			20, 20E, 20E Header Stop, 20E Atr., 25, 32D Ast., 88, 92E Ast., 95 (picture frame), 95E Ast., 99E Ast.,
OBS	WS-015	SEAL-92BTBRZ-36	Bronze bottom seal [36.00] alcryn 3065
			32 (used Oct. 2003- 2006), 92 (Used 2003-June 2013), 55, obsolete on 98 w/threshold Nov. 2014

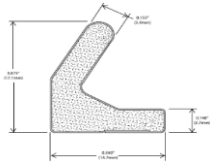

WS-016
Double Door Astragal
(August 2015 - Current)

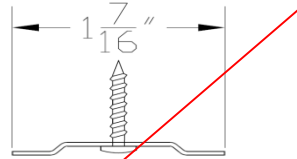

Obsolete
Series 32 "Taylor" Seal-holder
Most recent (2012) - needed for all WS-020 applications. Bottom of "old" Series 32 OUTSWING doors.
Some available for repair

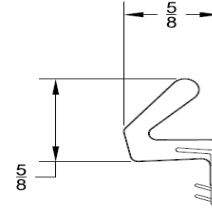

Compression Jamb Seal
WS-011

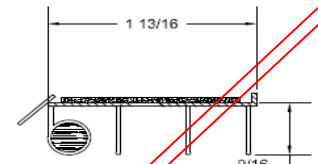

98FG SWEEP

Obsolete
WS-005
INSWING through 2012
(Feb. 2007 - 2013)

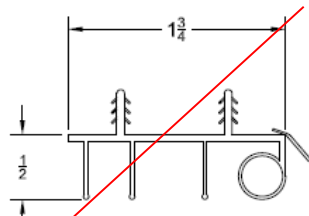

WS-015
(Obsolete) -Used 2003 -2006)
Available for replacement

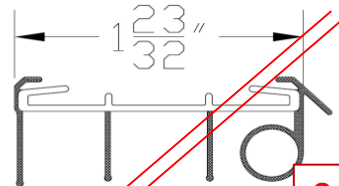

Obsolete
WS-020
(2006 - 2013) - works for all "old" Series 32 OUTSWING doors, bottom of door only.

Out of material - For replacement orders use WS-008

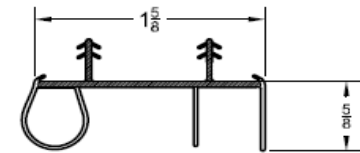

EVERLAST SWEEP
WS-006E
(All 32 TB May 2013 - current)
Bottom of door only

Modern Door Seal Replacement Reference

54 (Picture Frame)

Weather Seal #	SBT Part Number	Description	Where Used
WS-006-3/0-BRN	SEAL-99TBARN-35	Bronze T&B seal [35.9375]	99,94,95 (Picture Frame), 96, 77, 54
WS-006	SEAL-99TBARN-37	Bronze T&B seal [37.1875]	double door
WS-006-4/0-BRN	SEAL-99TBARN-46	Bronze T&B seal [46.4375]	99,94
WS-006	SEAL-99TBARN-47	Bronze T&B seal [47.6250]	double door
WS-012	SEAL-99S-WOOLP	(.320-4 High)(.270 wide) gray woolpile weather strip	99, 66, 96, 77, 54, 35, 31, 99E

****Note: WS-006 panel sweep changed color from white to brown in Oct. 2008**

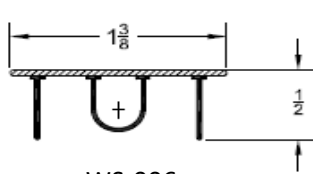

WS-006

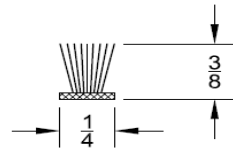

WS-012

Modern Door Seal Replacement Reference

55 OBSOLETE

Weather Seal #	SBT Part Number	Description	Where Used
OBS WS-001-3/0	SEAL92BTBR37	1302 bronze 37" - (92 bottom seal)	92, 94 handicap
OBS WS-001-4/0	SEAL92BTBR49	1302 bronze 49" - (92 bottom seal)	92, 94 handicap
WS-003	SEAL-92MAG-86BR	Bronze magnetic seal 85"	55, 92 strike & header
WS-006-3/0-BRN	SEAL-99TBBRN-35	Bronze T&B seal [35.9375]	99,94,95 (Picture Frame), 96, 77 (92 built b/4 2003)
WS-011-6/8	SEAL-92S-BRN81	Bronze Q-lon seal 81"	Bronze 32, 55, 92E, 27, 95E, 98, 20E Full Header
WS-011-7/0	SEAL-92S-BRN86	Q-lon seal 86"	
OBS WS-015	SEAL-92BTBRZ-36	Bronze bottom seal [36.00] alcryn 3065	32 (used Oct. 2003- 2006), 92 (Used 2003-June 2013), 55, obsolete on 98 w/threshold Nov. 2014
OBS WS-015	SEAL-92BTBRZ-48	Bronze bottom seal [48.00] alcryn 3065	

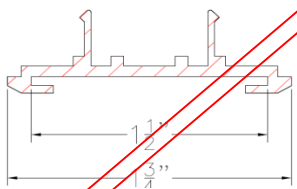

Seal Holder #1276

Obsolete

May 2003

No longer available

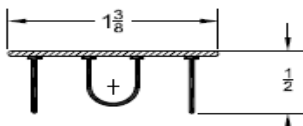

WS-006

Replacement sweep for
doors manufactured
before 2003

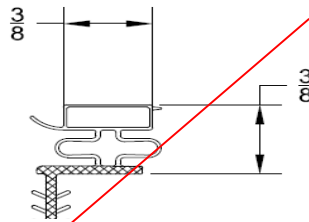

Obsolete

Magnetic Jamb Seal

WS-003

Use WS-011 for replacement

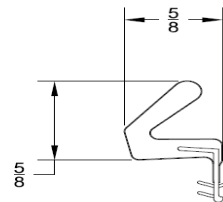

Compression Jamb Seal

WS-011

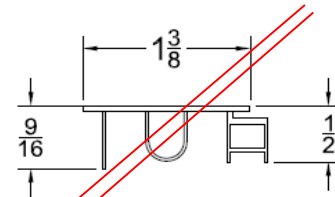

OLD 92 SWEEP

WS-001

Obsolete (May 2003)

No longer available

Order WS-006 for replacement,
4/0 doors will use the 12' length cut to 48"

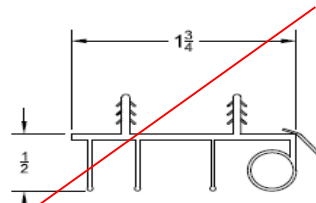

92 SWEEP

WS-015 92 Sweep

Obsolete on the 92 series
(Used from 2003 to June 2013)

Available for replacement

After May 2003 - Kerf Style

Modern Door Seal Replacement Reference

66 OBSOLETE (Dec. 2021)

Weather Seal #	SBT Part Number	Description	Where Used
WS-012	SEAL-99S-WOOLP	(.320-4 High)(.270 wide) gray woolpile weather strip	99, 66, 96, 77, 54, 35, 31, 99E
OBS WS-014	SEAL-99JAMB-1	300 X 270 bronze bulb seal (1,000' reels)	66 (option, standard on 66-3453A) , 99
WS-017	SEAL-66BLKBULB	.300 wide x .375 high x .270 T slot black bulb seal	66 (option 99)

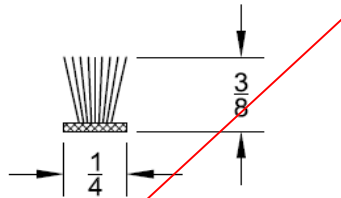

WS-012 **Obsolete**
 (on 66 series only) **Nov. 2017**
No longer an option - will not work with new series 66 frame extrusion.
Available for replacement on doors built before Nov. 2017

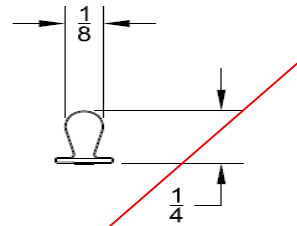

99 BULB SEAL
WS-014
 (Option available starting July 2016)
 Standard on 66-3453A
Obsolete Nov. 2017
No longer an option - will not work with new series 66 frame extrusion.
Available for replacement on doors built before Nov. 2017

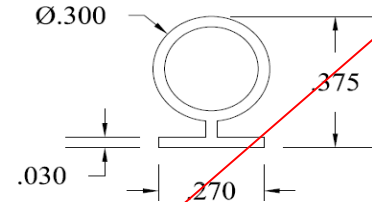

WS-017
 Current as of Nov. 2017
OBSOLETE Jan. 2022
 Available for replacement

66D

WS-026	SEAL-99BLKBULB	.270 wide x .237 oval dia. bulb w/finger	66D (option 99)
--------	----------------	--	-----------------

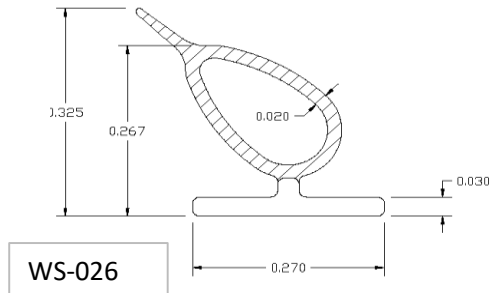

Modern Door Seal Replacement Reference

68E

Weather Seal #	SBT Part Number	Description	Where Used
WS-025-3/0	SEAL-EBRPVC36	Bronze T&B seal [35.750] Everlast PVC	68E, 99E
WS-025-4/0	SEAL-EBRPVC48	Bronze T&B seal [37.750] Everlast PVC	68E, 99E
WS-016-6/8	SEAL-20JBQ-BN81	Bronze 6-8 jamb seal 81"	20, 20E, 20E Header Stop, 20E Atr., 25, 32D Ast., 88, 92E Ast., 95 (picture frame), 95E Ast., 99E Ast.,
WS-016-7/0	SEAL-20JBQ-BN86	Bronze 7-0 jamb seal 86"	
	DUSTPLUG-1.25	1 1/4" Wide Dust Plug, Gray	20 ins., 31, 35, 88, 94, 96, 99, 99 double door, 99E

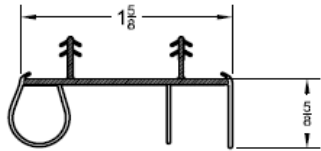

EVERLAST SWEEP - PVC
WS-025

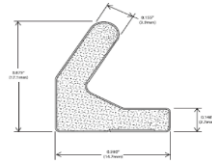

WS-016
Current
(August 2015 - current)

77 OBSOLETE

Weather Seal #	SBT Part Number	Description	Where Used
WS-006-3/0-BRN	SEAL-99TBBRN-35	Bronze T&B seal [35.9375]	99,94,95 (Picture Frame), 96, 77
WS-006	SEAL-99TBBRN-37	Bronze T&B seal [37.1875]	double door
WS-006-4/0-BRN	SEAL-99TBBRN-46	Bronze T&B seal [46.4375]	99,94
WS-006	SEAL-99TBBRN-47	Bronze T&B seal [47.6250]	double door
WS-012	SEAL-99S-WOOLP	(.320-4 High)(.270 wide) gray woolpile weather strip	99, 66, 96, 77, 54, 35, 31, 99E

**Note: WS-006 panel sweep changed color from white to brown in Oct. 2008

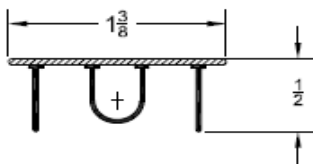

WS-006

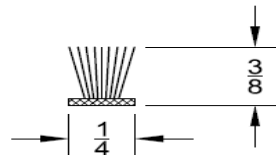

WS-012

Modern Door Seal Replacement Reference

88 (Picture Frame)

	Weather Seal #	SBT Part Number	Description	Where Used
OBS	WS-009-6/8	SEAL-88S-BRN81	Bronze adhesive backed seal 81" (tape #3M950)	88, 94, 95 (picture frame)
OBS	WS-009-7/0	SEAL-88S-BRN86	Bronze adhesive backed seal 86" (tape #3M950)	88, 94, 95 (picture frame)
	WS-010-3/0	SEAL-88TBBRN-35	Bronze T&B seal [35.9375]	88
	WS-010-4/0	SEAL-88TBBRN-46	Bronze T&B seal [46.4375]	88
OBS	WS-013/C-68	Z88JSHS-WS-009	Old 88 6/8 Stk Jamb "C" Seal Hold w/WS-009 Seal	88
OBS	WS-013/C-70		88 Strike Jamb Seal with Adjustable Seal Holder, 7/0	88
OBS	WS-013/CO-68	Z88JHSH	Old 88 "C" Channel Only - No seal - Stk Jamb 6/8	88
	WS-013/L-68		88 Hinge Jamb Seal with Adjustable Seal Holder, 6/8	88
	WS-013/L-70		88 Hinge Jamb Seal with Adjustable Seal Holder, 7/0	88
	WS-013/LO-68	Z88JSHH	88 Hinge Adjustable "L" Seal Holder ONLY, (no seal)	88, 95 (picture frame)
	WS-016-6/8	SEAL-20JBQ-BN81	Bronze 6-8 jamb seal 81"	20, 20E, 20E Header Stop, 20E Atr., 25, 32D Ast., 88, 92E Ast., 95 (picture frame), 95E Ast., 99E Ast.,
	WS-016-7/0	SEAL-20JBQ-BN86	Bronze 7-0 jamb seal 86"	
	WS-018		WS-010 Panel Seal with Panel Seal Holder	88
		DUSTPLUG-1.25	1 1/4" Wide Dust Plug, Gray	20 ins., 31, 35, 88, 94, 96, 99, 99 double door, 99E

**** NOTE**** Prior to June 1995 the 88 series panel seal was an individual bulb and an individual fin, this used extrusion 11237.

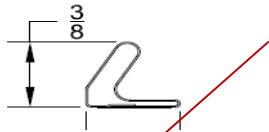

WS-009

with PSA (Stick-on) Tape
(Obsolete April 2016)

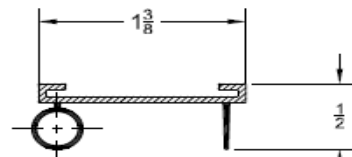

WS-010

Since Oct. 1995 Top and Bottom of All 88's

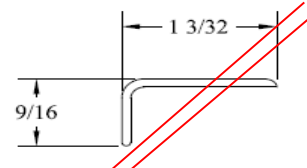

88 Seal Holder

WS-013/LO (hinge side)
(Obsolete April 2016)

No longer available

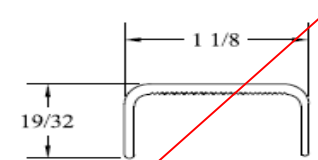

88 Seal Holder

WS-013/CO (strike side)
(Obsolete April 2016)

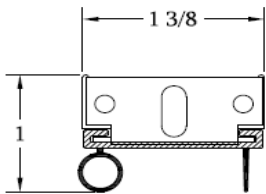

WS-018

Aluminum Panel Seal Holder W/Panel seal

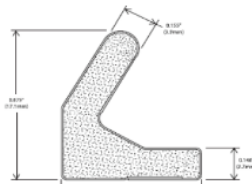

WS-016

(April 2016 - current)

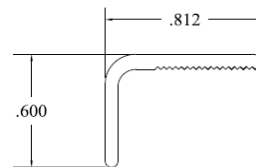

88 Seal Holder

WS-013/LO Strike & Hinge Jambs

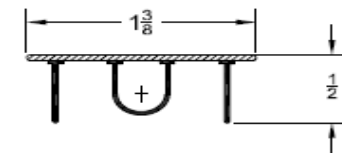

99 SWEEP

Replacement seal for Series 88 doors with ADA threshold. Applied with 2-sided tape.

Modern Door Seal Replacement Reference

92E

Weather Seal #	SBT Part Number	Description	Where Used
OBS	WS-001-3/0	SEAL92BTBR37	1302 bronze 37" - (92 bottom seal)
OBS	WS-001-4/0	SEAL92BTBR49	1302 bronze 49" - (92 bottom seal)
OBS	WS-003	SEAL-92MAG-86BR	Bronze magnetic seal 85"
	WS-006-3/0-BRN	SEAL-99TBBRN-35	Bronze T&B seal [35.9375]
	WS-011-6/8 WS-011-7/0	SEAL-92S-BRN81 SEAL-92S-BRN86	Bronze Q-Ion seal 81" Bronze Q-Ion seal 86"
OBS	WS-015	SEAL-92BTBRZ-36	Bronze bottom seal [36.00] alcryn 3065
OBS	WS-015	SEAL-92BTBRZ-48	Bronze bottom seal [48.00] alcryn 3065
OBS		TRIMTC92BW74	92 series panel top cap
OBS		SEAL-99TBBRN144	Bronze T&B seal [144.00"]
	WS-006E-3/0	SEAL-99EBR36	Bronze T&B seal [35.750] Everlast alcryn 4670
	WS-016-6/8 WS-016-7/0	SEAL-20JBQ-BN81 SEAL-20JBQ-BN86	Bronze 6-8 jamb seal 81" Bronze 7-0 jamb seal 86"

****Note: (for doors built before June 2013)** 92 Series jamb / header seal: Outswing doors have **Magnetic** Seal on the strike jamb and the header. Inswing doors have **Compression** Seal on the strike jamb and the header. **ALL** 92 series doors have Compression Seal on the hinge jamb.

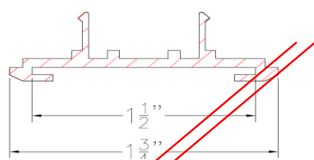

Seal Holder #1276
Obsolete May 2003

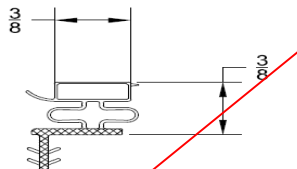

Magnetic Jamb Seal
WS-003

(Obsolete June 2013)
Use WS-011 for replacement

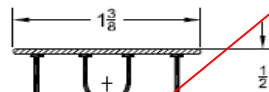

WS-006

Replacement sweep for doors
manufactured **before 2003**
(4/0 doors will need to have the 12'
seal cut to 48")

Available for replacement

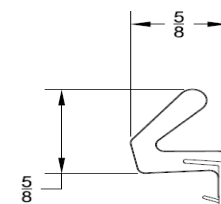

WS-011

Compression Jamb Seal used on all 92's

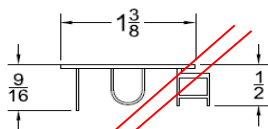

OLD 92 SWEEP
WS-001

Obsolete (May 2003)

No longer available

Order WS-006 for replacement,
4/0 doors will use the 12' length cut to 48"

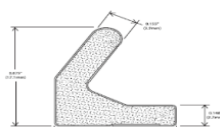

WS-016

Current

(August 2015 - current)

Used on Everlast series double door
astragals

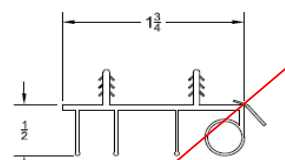

WS-015

Obsolete

(Obsolete -Used 2003 - June 2013)

Available for replacement



EVERLAST SWEEP
WS-006E

(Current as of June 2013 all 92 B)

Modern Door Seal Replacement Reference

92E (continued)

Thermal Panel Extension - 5/8"

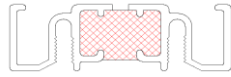

These thresholds require a panel extension.

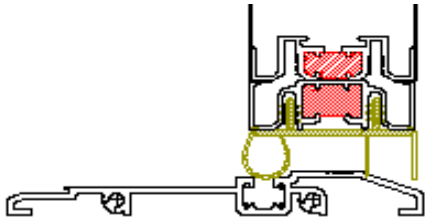

INSWING ADA

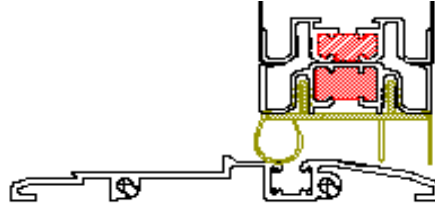

OUTSWING ADA

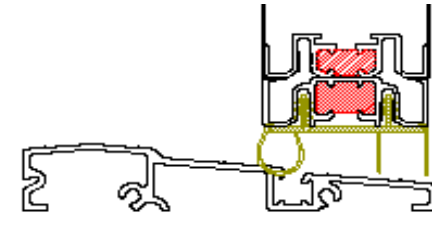

OUTSWING LW

This threshold does not require a panel extension.

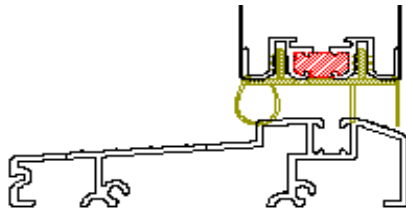

INSWING LW

Modern Door Seal Replacement Reference

94 (Picture Frame - Obsolete)

Weather Seal #	SBT Part Number	Description	Where Used	
OBS	SEAL-94S-BRN81	Bronze .625 w/ adhesive 81" Obsolete approx. 1996	94, 98	
OBS	SEAL-94S-BRN85	Bronze .625 w/ adhesive 85" Obsolete approx. 1996	94, 98	
	WS-006-3/0-BRN	SEAL-99TBBRN-35	Bronze T&B seal [35.9375]	99,94,95 (Picture Frame), 96, 77
	WS-006	SEAL-99TBBRN-37	Bronze T&B seal [37.1875]	double door
	WS-006-4/0-BRN	SEAL-99TBBRN-46	Bronze T&B seal [46.4375]	99, 94
	WS-006	SEAL-99TBBRN-47	Bronze T&B seal [47.6250]	double door
		SEAL-99TBBRN144	Bronze T&B seal [144.00"]	92
OBS	WS-009-6/8	SEAL-88S-BRN81	Bronze adhesive backed seal 81" (tape #3M950)	88, 94, 95 (picture frame)
OBS	WS-009-7/0	SEAL-88S-BRN86	Bronze adhesive backed seal 86" (tape #3M950)	88, 94, 95 (picture frame)
		Z88OFHTE-(color)-(size)	94 Series Handicap Threshold Extension	
		DUSTPLUG-1.25	1 1/4" Wide Dust Plug, Gray	20 ins., 31, 35, 88, 94, 96, 99, 99 double door, 99E
	WS-016-6/8	SEAL-20JBQ-BN81	Bronze 6-8 jamb seal 81"	20, 20E, 20E Header Stop, 20E Atr., 25, 32D Ast., 88, 92E
	WS-016-7/0	SEAL-20JBQ-BN86	Bronze 7-0 jamb seal 86"	Ast., 95 (picture frame), 95E Ast., 99E Ast.,

**Note: WS-006 panel sweep changed color from white to brown in Oct. 2008

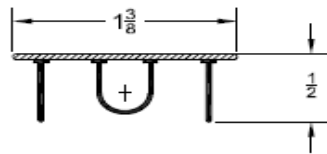

WS-006

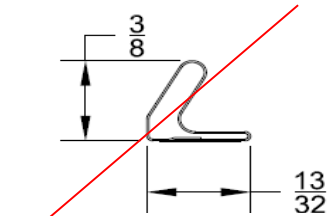

WS-009

Some available for replacement

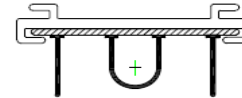

Z88OFHTE- (color)- (size)
with attached WS-006

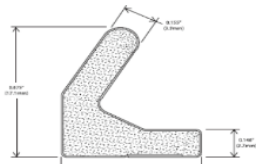

WS-016

(April 2016)

Modern Door Seal Replacement Reference

95 (Picture Frame) Obsolete

Weather Seal #	SBT Part Number	Description	Where Used
WS-006-3/0-BRN	SEAL-99TBBRN-35	Bronze T&B seal [35.9375]	99,94,95 (Picture Frame), 96, 77
WS-006	SEAL-99TBBRN-37	Bronze T&B seal [37.1875]	double door
WS-006-4/0-BRN	SEAL-99TBBRN-46	Bronze T&B seal [46.4375]	99, 94
WS-006	SEAL-99TBBRN-47	Bronze T&B seal [47.6250]	double door
OBS WS-009-6/8	SEAL-88S-BRN81	Bronze adhesive backed seal 81" (tape #3M950)	88, 94, 95 (picture frame)
WS-013/LO-68	Z88JSHH	88 Hinge Adjustable "L" Seal Holder ONLY, (no seal)	88, 95 (picture frame)
WS-009-7/0	SEAL-88S-BRN86	Bronze adhesive backed seal 86" (tape #3M950)	88, 94, 95 (picture frame)
WS-016-6/8	SEAL-20JBQ-BN81	Bronze 6-8 jamb seal 81"	20, 20E, 20E Header Stop, 20E Atr., 25, 32D Ast., 88, 92E
WS-016-7/0	SEAL-20JBQ-BN86	Bronze 7-0 jamb seal 86"	Ast., 95 (picture frame), 95E Ast., 99E Ast.,

**Note: WS-006 panel sweep changed color from white to brown in Oct. 2008

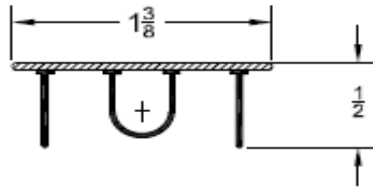

WS-006

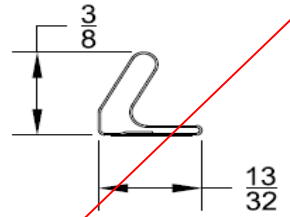

WS-009

Obsolete April 2016
Some available for replacement

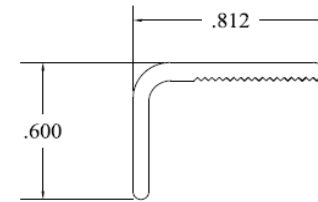

88 Seal Holder WS-013/LO Strike & Hinge Jamb
Current
(April 2016 - current , used on all doors.)

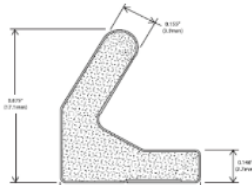

WS-016

Current
(April 2016 - current)

Modern Door Seal Replacement Reference

95E & 85E

Weather Seal #	SBT Part Number	Description	Where Used
WS-006E-3/0	SEAL-99EBR36	Bronze T&B seal [35.750] Everlast alcryn 4670	24E, 99E, 95E, 20E, 32E, 92E
WS-011-6/8	SEAL-92S-BRN81	Bronze Q-Ion seal 81" Bronze	32, 55, 92E, 27, 95E, 98, 20E Full Header
WS-011-7/0	SEAL-92S-BRN86	Q-Ion seal 86"	
	DUSTPLUG-1.25	1 1/4" Wide Dust Plug, Gray	20 ins., 31, 35, 88, 94, 96, 99, 99 double door, 99E

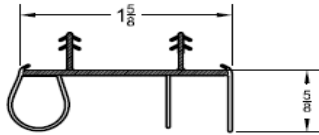

EVERLAST SWEEP
WS-006E

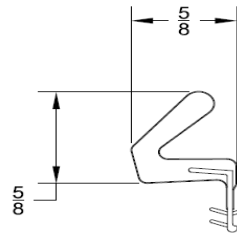

WS-011
Compression Jamb Kerf Seal

96 (Picture Frame)

Weather Seal #	SBT Part Number	Description	Where Used
WS-012	SEAL-99S-WOOLP	(.320-4 High)(.270 wide) gray woolpile weather strip	99, 66, 96, 77, 54, 35, 31, 99E
WS-006-3/0-BRN	SEAL-99TBBRN-35	Bronze T&B seal [35.9375]	99,94,95 (Picture Frame), 96, 77
WS-006	SEAL-99TBBRN-37	Bronze T&B seal [37.1875]	double door
WS-006-4/0-BRN	SEAL-99TBBRN-46	Bronze T&B seal [46.4375]	99,94
WS-006	SEAL-99TBBRN-47	Bronze T&B seal [47.6250]	double door
	DUSTPLUG-1.25	1 1/4" Wide Dust Plug, Gray	20 ins., 31, 35, 88, 94, 96, 99, 99 double door, 99E

****Note: WS-006 panel sweep changed color from white to brown in Oct. 2008**

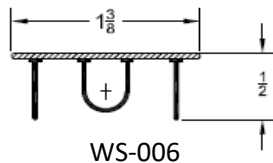

WS-006

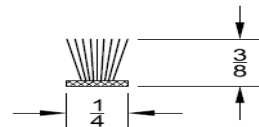

WS-012

Modern Door Seal Replacement Reference

98

	Weather Seal #	SBT Part Number	Description	Where Used
OBS	WS-002-6/8	SEAL-HD-BRN81	Bronze double contact seal - 81" - Obsolete 8/2010	was 98
OBS	WS-002-7/0	SEAL-HD-BRN86	Bronze double contact seal - 86" - Obsolete 8/2010	was 98
	WS-004	SEAL-98BLK-100	Black HD Bottom Seal - 108"	98 (without threshold)
OBS	WS-005-3/0	SEAL-20TB36-1	Bronze 3-0 seal [35.8125] - screw on 1 bulb / 3 fin	32 inswing, 98 w/ thres. Obsolete Nov. 2013
OBS	WS-005-3/8	SEAL-20TB42-1	Bronze 3-6 seal [41.8125] - screw on 1bulb / 3 fin	32 inswing, 98 w/ thres. Obsolete Nov. 2013
	WS-011-6/8 WS-011-7/0	SEAL-92S-BRN81 SEAL-92S-BRN86	Bronze Q-lon seal 81" Q-lon seal 86"	Bronze 32, 55, 92E, 27, 95E, 98, 20E Full Header
OBS	WS-015	SEAL-92BTBRZ-36	Bronze bottom seal [36.00] alcryn 3065	92 (Used 2003 - June 2013), 55, 98 w/threshold - obsolete for 98 series Nov. 2014
	WS-006E	SEAL-99EBR	Bronze T&B seal Everlast alcryn 4670	99E, 95E, 20E, 32E, 98 (with threshold)

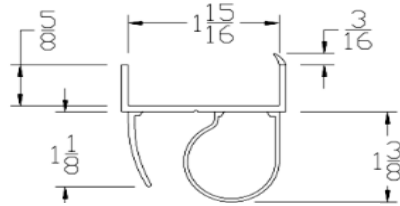

WS-004

Used without threshold

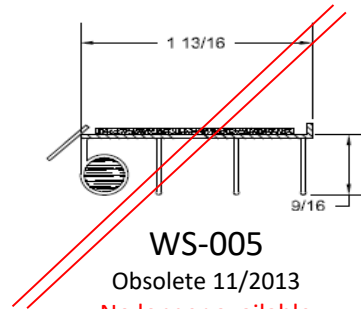

WS-005

Obsolete 11/2013
No longer available

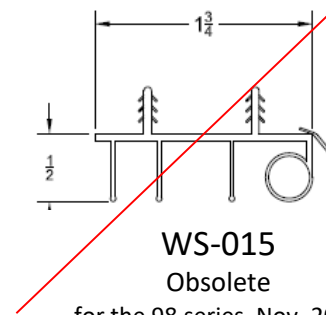

WS-015
Obsolete

for the 98 series Nov. 2014
Available for replacement

98 JAMB SEAL
WS-002 Obsolete 8/2010
No longer available

Replaced with

WS-011
(9/2010 - current)

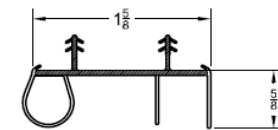

EVERLAST SWEEP

WS-006E

Current as of Nov. 2014
Bottom of Door, used with threshold (fins are removed and double sided tape is added)

Modern Door Seal Replacement Reference

99 (Picture Frame)

Weather Seal #	SBT Part Number	Description	Where Used
WS-006-3/0-BRN	SEAL-99TBBRN-35	Bronze T&B seal [35.9375]	99,94,95 (Picture Frame), 96, 77
WS-006	SEAL-99TBBRN-37	Bronze T&B seal [37.1875]	double door
WS-006-4/0-BRN	SEAL-99TBBRN-46	Bronze T&B seal [46.4375]	99,94
WS-006	SEAL-99TBBRN-47	Bronze T&B seal [47.6250]	double door
WS-012	SEAL-99S-WOOLP	(.320-4 High)(.270 wide) gray woolpile weather strip	99, 66, 96, 77, 54, 35, 31, 99E
WS-014	SEAL-99JAMB-1	300 X 270 bronze bulb seal (1,000' reels)	66, 99
WS-017	SEAL-66BLKBULB	.300 wide x .375 high x .270 T slot black bulb seal	66 (option 99)
	DUSTPLUG-1.25	1 1/4" Wide Dust Plug, Gray	20 ins., 31, 35, 88, 94, 96, 99, 99 double door, 99E
WS-026	SEAL-99BLKBULB	.270 wide x .237 oval dia. bulb w/finger	66D (option 99)

****Note: WS-006 panel sweep changed color from white to brown in Oct. 2008**

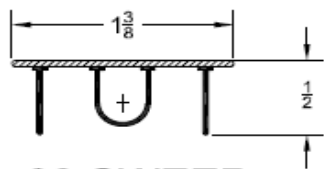

99 SWEEP
WS-006

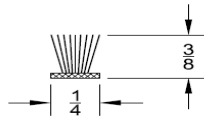

99 FUZZY SEAL
WS-012 Wool Pile T-Seal
Used on all 99's & 99E's

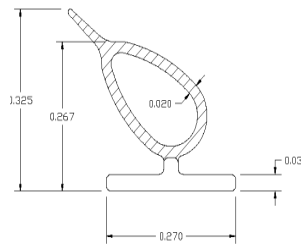

WS-026

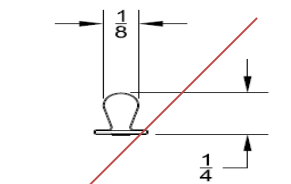

~~**99 BULB SEAL**~~
WS-014

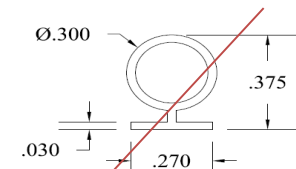

~~**WS-017**~~
Current as of Nov. 2017
OBSOLETE Jan. 2022
Available for replacement

99E

Weather Seal #	SBT Part Number	Description	Where Used
WS-025-3/0	SEAL-EBRPVC36	Bronze T&B seal [35.750] Everlast PVC	68E, 99E
WS-025-4/0	SEAL-EBRPVC48	Bronze T&B seal [37.750] Everlast PVC	68E, 99E
WS-006E	SEAL-99EBR37	Bronze T&B seal [37.000] Everlast alcryn 4670	Double Door - 95E, 20E, 32E
WS-006E	SEAL-99EBR49	Bronze T&B seal [49.000] Everlast alcryn 4670	Double Door - 95E, 20E, 32E
WS-012	SEAL-99S-WOOLP	(.320-4 High) (.270 wide) gray woolpile weather strip	99, 66, 96, 77, 54, 35, 31, 99E
	DUSTPLUG-1.25	1 1/4" Wide Dust Plug, Gray	20 ins., 31, 35, 88, 94, 96, 99, 99 double door, 99E

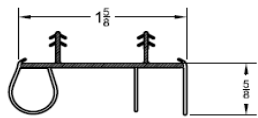

EVERLAST SWEEP
WS-006E

Used for 99E double doors

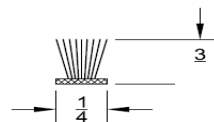

99 FUZZY

WS-012 Wool Pile T-Seal
Used on all 99's & 99E's
Difficult to replace.

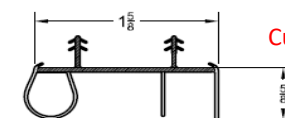

EVERLAST SWEEP - PVC
WS-025

Top & Bottom of Doors

Current 4/20/2020