

PLYCO® Series 22/23 Standard Hardware Options

Plyco® offers a full range of UL Listed hardware options available for the Series 22/23 to meet commercial and fire rated walk door requirements. Listed below are our most popular hardware for the Series 22/23 door. Additional hardware is available.

PREHUNG DOOR - Frame is welded and prepped for wall installation. Door is hung in the frame. Threshold weather seal and sweep installed.

PREASSEMBLED DOOR - In addition to the above, all hardware is installed and a C-channel subframe system is included and installed.

CYLINDRICAL & MORTISE LOCKSETS

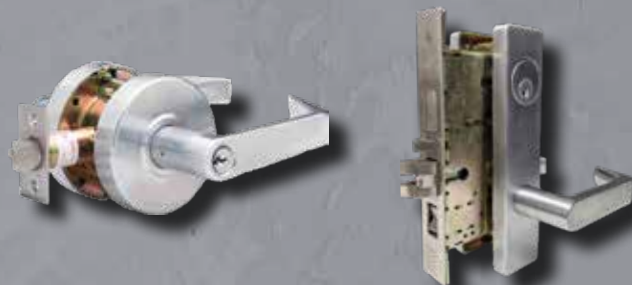

NUMEROUS JAMB SIZES

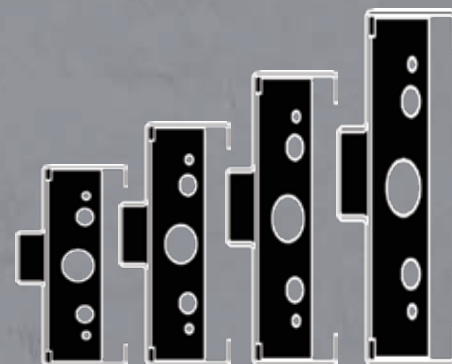

PANIC BARS AND TRIM - GRADE 1

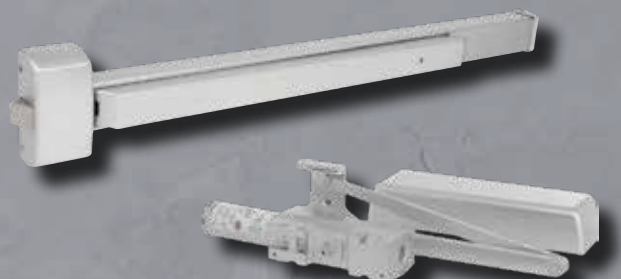

LITE KITS

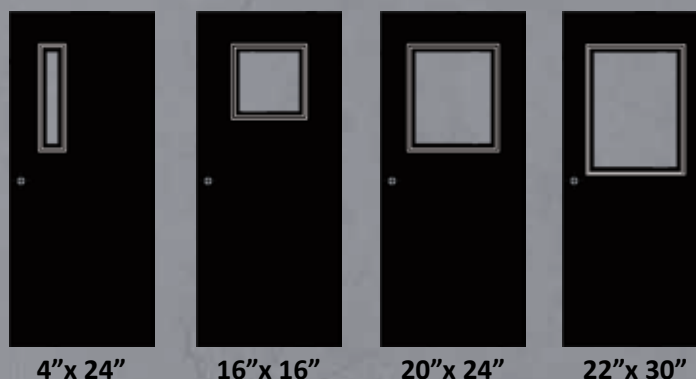

4"x 24" 16"x 16" 20"x 24" 22"x 30"

CLOSERS - GRADE 1

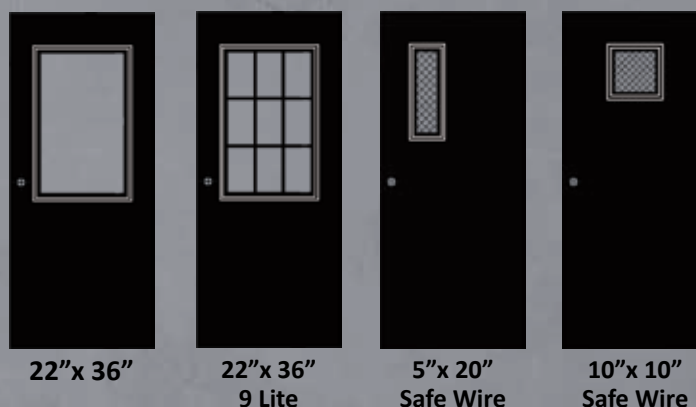

22"x 36" 22"x 36" 9 Lite 5"x 20" Safe Wire 10"x 10" Safe Wire

OTHER DOOR ACCESSORIES

- Electronic locks and strikes
- Aluminum kick plate
- Zinc plated latch guard
- Schlage hardware
- Commercial door louver 18x12 (FDLS) inverted "Y" Style

PLYCO® CORPORATION

SERIES 22/23

COMMERCIAL WALK DOOR SYSTEM
PRE-HUNG OR PRE-ASSEMBLED



- Post Frame
- Metal Frame
- Masonry
- Fire Rated



PLYCO CORPORATION
PO BOX 386 • ELKHART LAKE, WI 53020

www.plyco.com 800/558-5895 FAX: 800/257-5926
INTERNATIONAL 920/876-3611 FAX: 920/876-3527

WINDOWS • WALK DOORS • WALL VENTS • RIDGE VENTS
SLIDING DOOR TRACK • SLIDE DOOR RAILS • PLY-FOIL INSULATION
HORSE STALLS • FASTENERS & CLOSURES • SPECIALTY PRODUCTS

INTERTEK/WHI Listed for Fire Rated Applications

SDI LEVEL 2 - 18 ga door & 16 ga frame • Factory Finish Painted

Post Frame Commercial Door

Metal Frame Commercial Door



The Series 22/23 features:

- Pre-Painted factory finish coat white (other colors available)
- 18 gauge A40 Galv. door panel
- 4 3/4" or 5 3/4" stock frame depths (other depths available)
- Meets all SDI Standards
- Cylindrical or mortise lock preps
- Closer reinforcement in door panel and frame
- Door assembly R-Value: 2.22 (ASTM C1363)
- Large selection of hardware options
- STC Rated 26

- Class "A" or "B" Fire Door Labeled available. Up to 3-hour rating
- 16 gauge A40 Galv. steel frame
- Welded mitered jamb header connection - not butted
- Hinge reinforcements for standard or heavy duty hinge applications (10 ga)
- Stainless steel hinges standard
- High performance sweep/threshold combination
- Includes frame anchors for for any wall application, including masonry, steel stud, wood stud, wood framed or existing masonry



Post Frame Anchor System

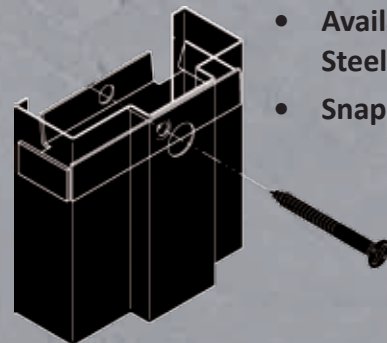

- Available for 5 3/4" Steel Jamb
- Snap-In "CO" Anchor

Welded Miter Corners

Specified for their seamless appearance and to ensure the frames are square at time of installation. Welded Frames reduce job-site labor required to assemble and properly install

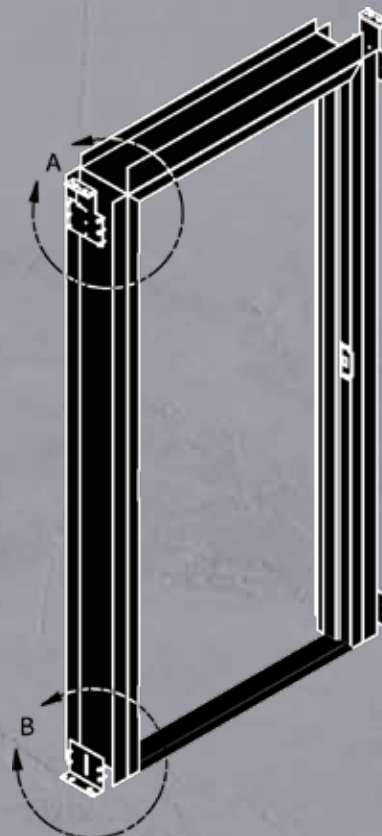
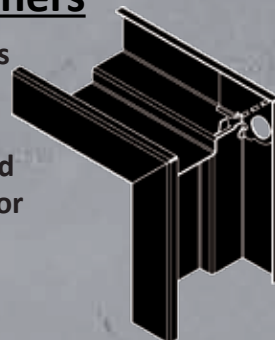

Standard Subframe

- 4" x 2" Head Flange
- All Depths
- 16 GA A40 Galv. Steel
- Subframe adjustable Head Clip (A)
- Subframe Floor clip w/masonry fasteners (B)

Commercial Anchor options

- Masonry Anchor
- Self-Drilling Anchor
- Dynabolt Anchor
- Punch & Draw - Lag Anchor
- Bolted Anchor

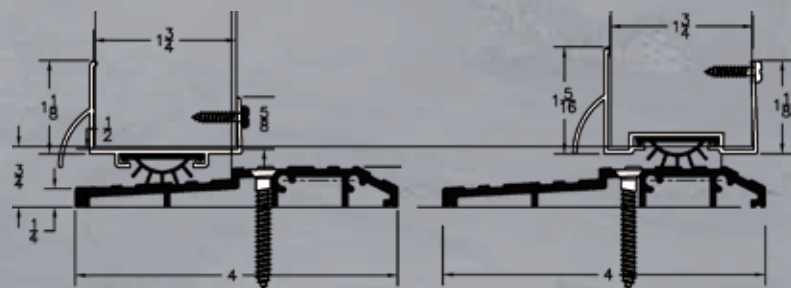
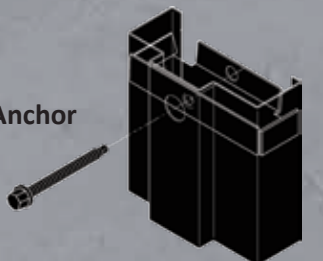

Superior Door Seal System for inswing and outswing doors
(Fire rated doors have saddle type threshold)